

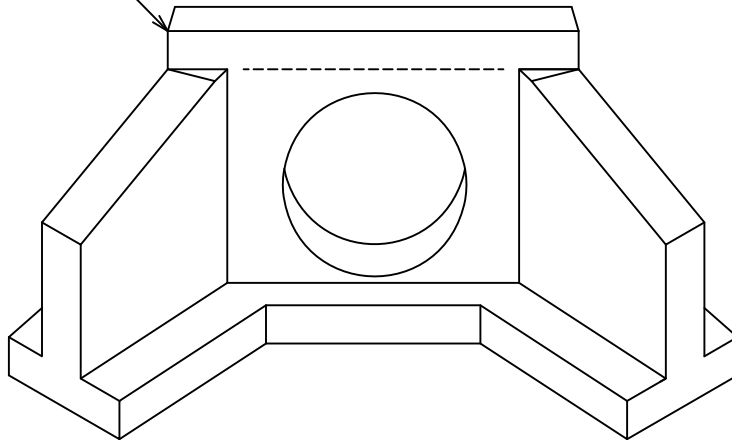

MONARCH

MONARCH PRODUCTS COMPANY, INC.
YORK HAVEN, PA.

AVAILABLE WITHOUT
TOP RISER SECTION



—ISOMETRIC—

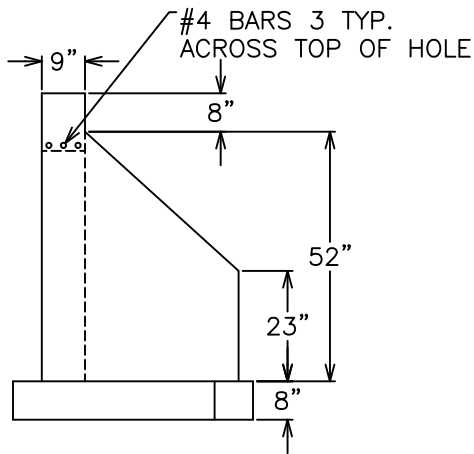

—SIDE VIEW—

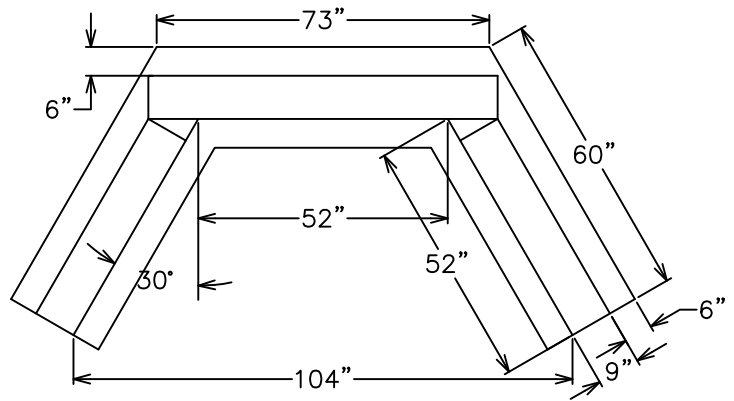

—PLAN VIEW—

NOTE: REINFORCEMENT TO BE 0.12 IN²/FT. EACH WAY

TYPE D-W ENDWALL
MAXIMUM PIPE SIZE — 48" C.M.P.

DWG. OS-3