

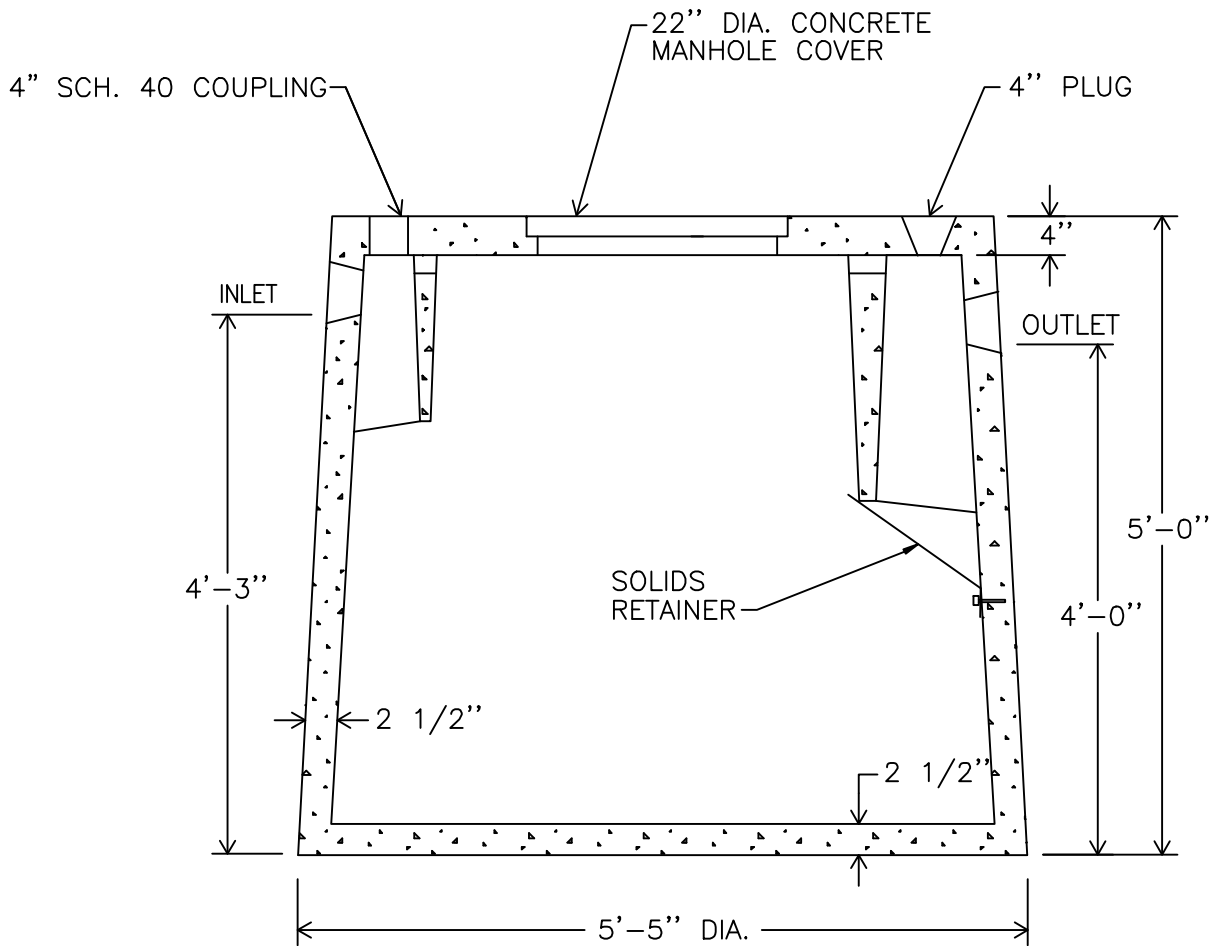

MONARCH

MONARCH PRODUCTS COMPANY, INC.
YORK HAVEN, PA.



-SECTION ELEVATION-

PRECAST SEPTIC TANK
500 GALLON CAPACITY

DWG. ST-5